



IMPRESSA X7

Instructions for use



tel 0870 207 4831 | email mail@redmonkeycoffee.com

www.redmonkeycoffee.co.uk



Art. Nr. 62565 – 4/03

IMPRESSA

if you love coffee

Nur für UL-geprüfte Geräte gültig – Valable seulement pour certifiées machines UL – Valide solo per apparecchi sottoposti a controlli UL – Only valid for UL-approved machines / Sólo válido para aparatos clasificados como UL – Alleen voor UL-gekeurde apparaten geldig.

IMPORTANT SAFEGUARDS

When using electrical appliances, basic safety precautions should always be followed, to reduce the risk of fire, electric shock, and/ or injury to persons, including the following:

- Read all instructions.
- Do not touch hot surfaces. Use handles or knobs.
- To protect against fire, electric shock and personal injury do not immerse cord, plugs, or appliance in water or other liquid.
- Close supervision is necessary when any appliance is used by or near children.
- Unplug from outlet any when not in use and before cleaning. Allow to cool before putting on or taking off parts, and before cleaning the appliance.
- Do not operate any appliance with a damaged cord or plug or after the appliance malfunctions, or has been damaged in any manner. Return appliance to the nearest authorized service facility for examination, repair or adjustment.
- The use of accessory attachments not recommended by the appliance manufacturer may result in fire, electric shock or personal injury.
- Do not use outdoors.
- Do not let cord hang over edge of table or counter, or touch hot surfaces.
- Do not place on or near a hot gas or electric burner, or in a heated oven.
- Always attach plug to appliance first, then plug cord into the wall outlet. To disconnect, turn any control “off”, then remove plug from wall outlet.
- Do not use appliance for other than intended use.
- Use extreme caution when disposing steam.
- For household and commercial use.

SAVE THESE INSTRUCTIONS

SPECIAL CORD SET INSTRUCTIONS

Regarding your Cord set.

- A short power-supply cord (or detachable power-supply cord) is to be provided to reduce risks resulting from becoming entangled in or tripping over a longer cord.
- Longer detachable power-supply cords or extension cords are available and may be used if care is exercised in their use.
- If a long detachable power-supply cord or extension cord is used, (1) the marked electrical rating of the detachable power-supply cord or extension cord should be at least as great as the electrical rating of the appliance, (2) if the appliance is of the grounded type, the extension cord should be a grounding type 3-wire cord, and (3) the longer cord should be arranged so that it will not drape over the counter top or table top where it can be pulled on by children or tripped over.
- **WARNING: To reduce the risk of fire or electric shock, do not remove any service covers. No user serviceable parts inside. Repair should be done by authorized personnel only.**

CAUTION:

This appliance is for household and commercial use. Any servicing other than cleaning and user maintenance should be performed by an authorized service representative.

- Do not immerse base in water or try to disassemble.
- To reduce the risk of fire or electric shock, do not remove the base. No user serviceable parts inside. Repair should be done by authorized service personnel only.
- Check voltage to be sure that the voltage indicated on the name plate agrees with your voltage.
- Never use warm or hot water to fill the water container! Use cold water only!
- Keep your hands and the cord away from hot parts of the appliance during operation.
- Never clean with scouring powders or hard implements.

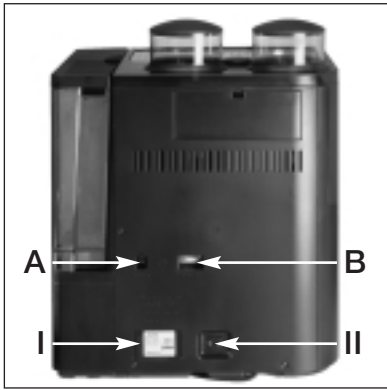

Fig. 1

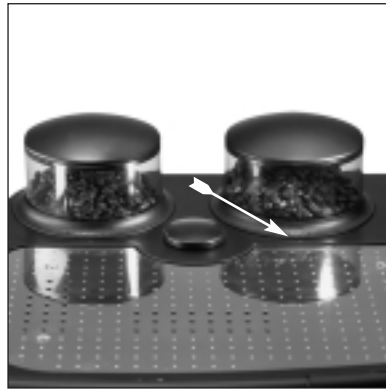

Fig. 2



Fig. 3



Fig. 4



Fig. 5

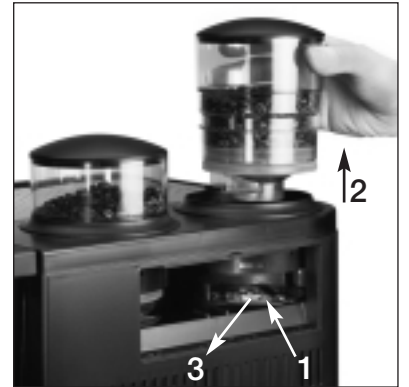

Fig. 6



Fig. 7

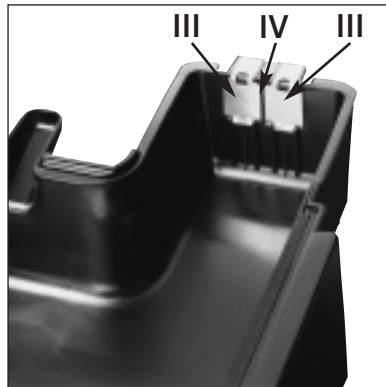

Fig. 8



Fig. 9



Fig. 10



Fig. 11

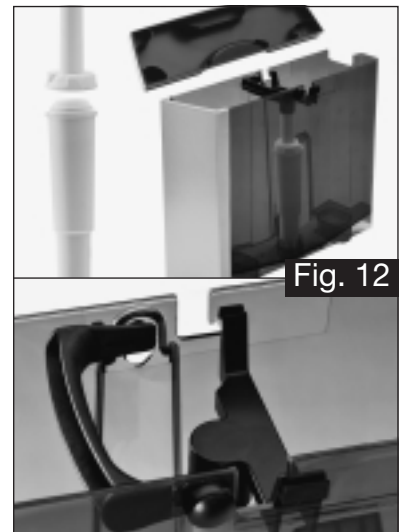
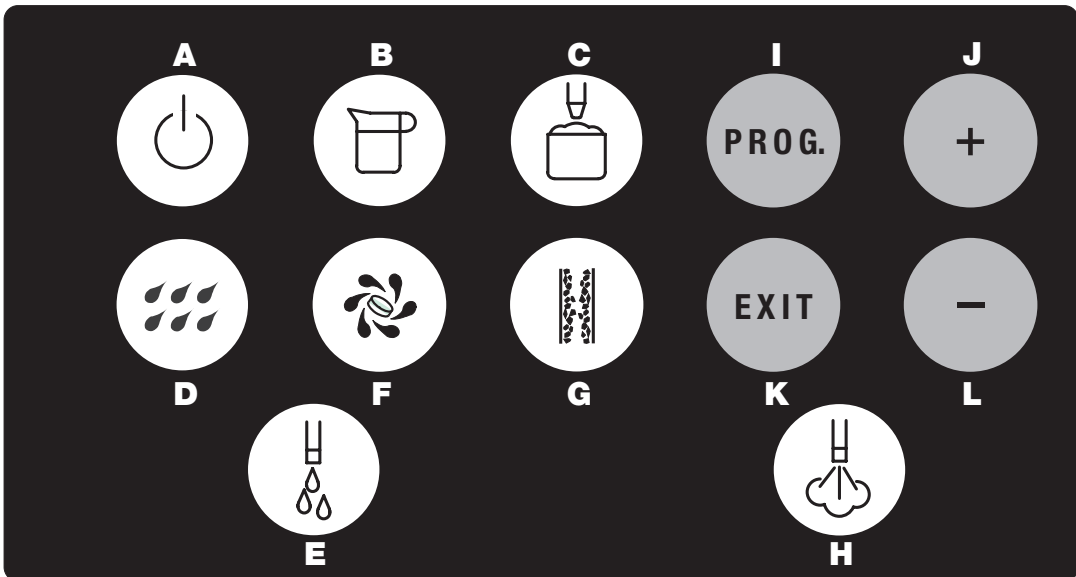
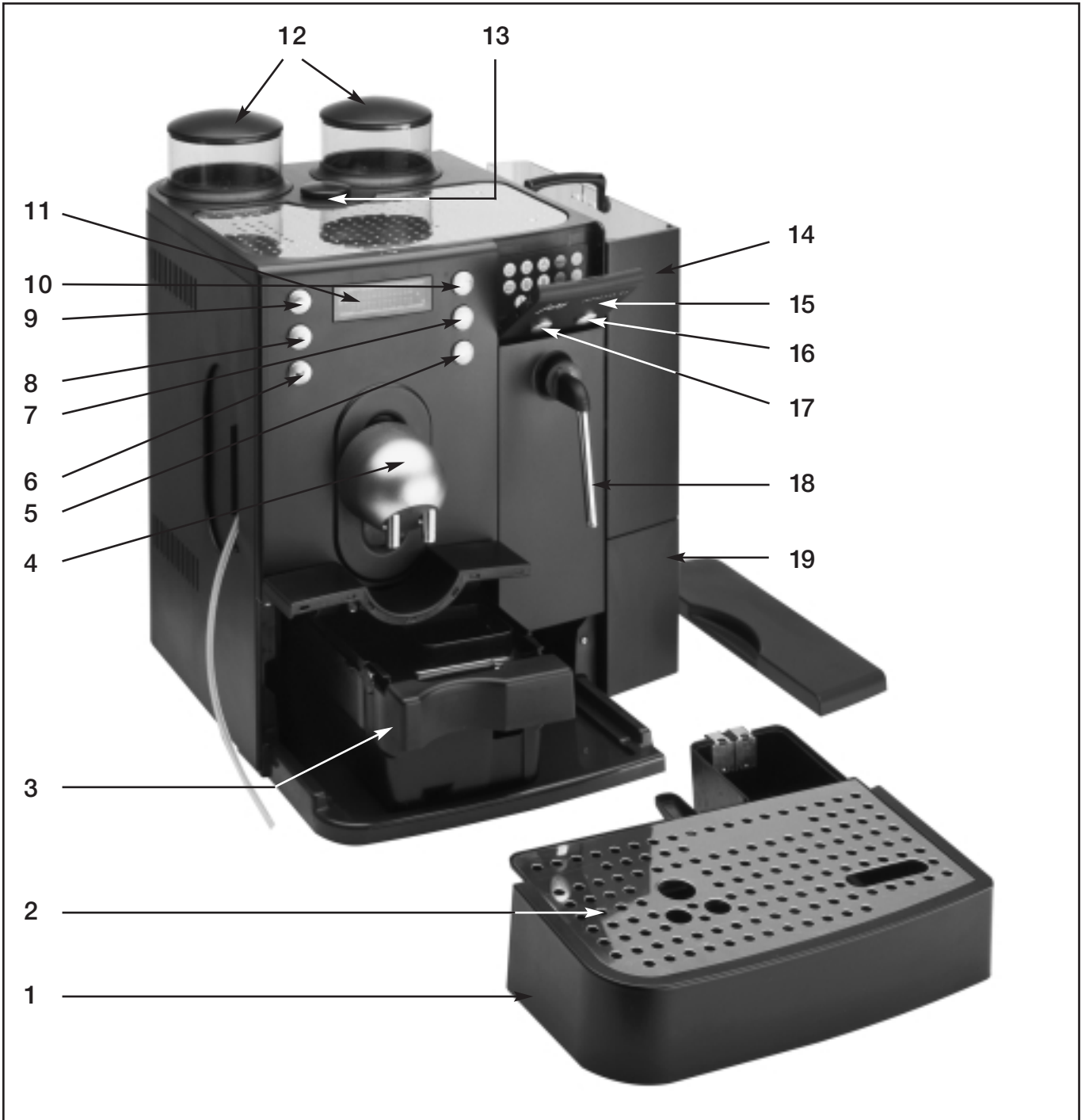

Fig. 12



Operating elements Jura Impressa X7

1. Drip tray
2. Drip tray cover
3. Ground container
4. Height-adjustable coffee and cappuccino spout
5. Draw-off button 2 coffees
6. Draw-off button 2 Espressos
7. Draw-off button 1 coffee
8. Draw-off button 1 Espresso
9. Draw-off button Cappuccino
10. Selector key for grinder
11. Display dialogue system
12. Grinders
13. Funnel for cleaning tablets
14. Water tank
15. Cover for programming keys
16. Draw-off button steam
17. Draw-off button hot water
18. Pivoting nozzle for hot water/steam
19. Accessory drawer

Programming keys / Coffee key

- A ON/OFF switch
- B Draw-off button pot
- C Draw-off button milk froth
- D Rinsing key
- E Draw-off button hot water
- F Cleaning button
- G Descaling button
- H Draw-off button steam
- I Open program
- J Forward-setting of criteria / changing of memory indications up-wards
- K Close program
- L Back-setting of criteria / changing of memory indications downwards

Legend:

- **DISPLAY** DISPLAY: serves as information.
- **DISPLAY** **DISPLAY**: please follow the instructions shown.

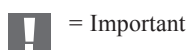
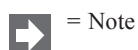

tel 0870 207 4831 | email mail@redmonkeycoffee.com

www.redmonkeycoffee.co.uk

Table of contents

Jura Impressa X7

1. Description	page 7
2. Safety instructions	page 7
2.1 Warnings	page 7
2.2 Safety precautions	page 7
3. Preparing the machine	page 7
3.1 Checking the mains voltage	page 7
3.2 Checking the fuse	page 7
3.3 Filling the water tank	page 7
3.4 Adding coffee beans	page 7
4. Switching the machine on	page 7
5. Rinsing the machine	page 7
6. Selecting the grinder	page 7
6.1 Setting the grinder	page 7
7. Adjusting the grinder	page 8
8. Adjusting of water hardness	page 8
9. Installing the Claris filter cartridge	page 8
9.1 Installing the filter	page 8
9.2 Replacing the filter	page 8
10. Coffee	page 8
10.1 Drawing off coffee / espresso	page 8
10.2 Drawing off cappuccino	page 8
10.3 Drawing off pots of coffee	page 8
11. Drawing off hot water	page 9
12. Drawing off steam	page 9
13. Drawing-off milk froth	page 9
14. Switching the machine off	page 9
15. Programming	page 9
15.1 Programming grinding amount	page 9
15.2 Programming Temperature	page 9
15.3 Programming amount of water	page 9
15.4 Programming amount of milk	page 9
15.5 Programming portion of hot water	page 10
15.6 Programming water hardness	page 10
15.7 Programming clock	page 10
15.8 Programming machine on	page 10
15.9 Programming machine off	page 10
15.10 Draw-offs	page 10
15.11 Programming language	page 10
16. Care and maintenance	page 10
16.1 Fill water	page 10
16.2 Installation of an automatic filling device	page 10
16.3 Empty grounds container	page 10
16.4 Empty drip tray	page 10
16.5 Grounds container missing	page 10
16.6 Drip tray missing	page 10
16.7 Fill beans	page 11
16.8 Removing foreign objects	page 11
16.9 Clean machine	page 11
16.10 Machine scaled	page 11
16.11 Clean contacts	page 11
16.12 General cleaning instructions	page 11
17. Cappuccino cleaning	page 11
18. Combined cleaning	page 11
19. Coffee cleaning	page 12
20. Descaling	page 12
21. Disposal	page 12
22. Adjustments by the Jura service technician	page 12
23. Tips for perfect coffee	page 12
24. Messages	page 13
25. Problems	page 13
26. Legal information	page 14
27. Technical specifications	page 14

Important information for the user

Thank you for choosing this Jura product.

Please study these instructions carefully before using your new machine and keep them in a safe place for easy reference in the future.

Should you require further information or should particular problems occur that are not dealt with in sufficient detail for you in these operating instructions, then please ask your local dealer for the information you require or get in touch with us directly.

1. Description

The first Impressa for the office and small gastronomy area is outstanding not only because of its modern technology, but also a number of features, and prepares 1 or 2 cups of espresso/coffee in only one brewing process. The intelligent pre-brew aroma system (I.P.B.A.S.®) ensures that the full coffee aroma is made use of and supplies the best espresso/coffee, guaranteed to be covered by a splendid froth. Optionally, coffee can be used from either of the grinders, and the mixture can be programmed individually. Drawing-off cappuccino is possible at the push of a button and without moving the cups. Integrated rinsing, cleaning and de-scaling programmes ensure perfect cleanliness at the push of a button.

2. Safety instructions

2.1 Warnings

- Children are unaware of the dangers that can be caused by electrical machines; for this reason, children should never be left unsupervised with electrical machines.
- The machine may only be used by people who have been instructed.
- Never use a faulty machine or one with a damaged power cable.
- Never immerse the machine in water.

2.2 Safety precautions

- Never expose the machine to the effects of weather (rain, snow, frost) and never operate it with your hands wet.
- Place your machine on a solid and level surface. Never leave it on a warm or hot surface (hobs). Choose a location that is inaccessible for children or pets.
- Remove the plug from the power socket if you are away for some time (holidays etc.).
- Always remove the plug from the power socket before cleaning.
- When removing the plug from the power socket, never tug on the cord or the machine itself.
- Never repair or open the machine yourself. Repairs may only be done by authorised service centres using original spare parts and accessories.
- The machine is connected to the mains power socket via an electric cable. Please ensure that no-one trips over the cable and pulls the machine down. Keep children and pets at a distance.
- Never put the machine or parts of it into the dishwasher.
- To prevent overheating, please put the machine in a place with a good circulation of air.
- If you use de-scaling agents containing acid, remove any splashes and drips on sensitive surfaces, in particular natural stone and wood surfaces, straight away or take corresponding safety precautions.

3. Preparing the machine

3.1 Checking the mains voltage

The machine has been set to the correct mains voltage in the factory. Ensure that your mains voltage corresponds to the details on the rating plate attached to the reverse of your machine (Fig. 1/A).

3.2 Checking the fuse

Check whether the fuse matches your machine.

3.3 Filling the water tank

- Remove the water tank and rinse it out well with cold tap water.
- Then fill the water tank and put it back into the machine. Please ensure that the tank locks in properly.

▶ Please only use fresh, cold water. Never fill up with milk, mineral water and other fluids. You can also top up water without removing the tank. Simply remove the cover and pour in the water from above with a vessel and replace the lid again.

3.4 Adding coffee beans

You have the possibility of adding two different sorts of coffee beans.

- Remove the cover from the bean container.
- Clean out any dirt or foreign objects from the bean container.
- Fill coffee beans into the bean container and replace the cover again.

4. Switching the machine on

- Operate the switch on the reverse of the machine (Fig. 1/II).
- Switch the machine on with the ON/OFF  operating switch.
- **DISPLAY** : PLEASE WAIT
- Place an empty cup under the coffee spout (4).
- **DISPLAY** : RINSE UNIT

▶ The rinsing is done first via the cappuccino nozzle, after which the coffee spout is cleaned..

5. Rinsing the machine

A rinsing process is automatically started when the machine is switched off.

However, if no cappuccino has been drawn off, the rinsing is only done via the coffee spout when switching off. When the machine has been switched off and has cooled down, the rinsing process is requested when it is switched on again.

6. Selecting the grinder

You can select the grinder manually

- Press the key  1x or 2x. The light above the key tells you which grinder has been activated (grinder left or grinder right).

6.1 Setting the grinder

So that the coffee can be matched to the grinder as well as possible, carry out the following steps:

- Press the key 
- Draw off 6 coffee and 6 espresso by manually selecting the grinder “left” and then the grinder “right”.

- ➔ We recommend that you also readjust the grinder after:
 - a change of sort of coffee beans
 - extreme changes of the degree of grinding
 - service

7. Adjusting the grinder

You have the opportunity of adapting the grinder to the roast of your coffee. We recommend the following:

for a light roast → a finer adjustment
for a dark roast → a coarser adjustment

- To adjust the grinding, turn the setting rings into the required position (Fig. 2)
- You have the following options:
 - the smaller the dots, the finer the grinding
 - the larger the dots, the coarser the grinding

➔ The grinding may only be adjusted with the grinder in operation.

8. Adjustment of water hardness

Water is heated in the machine. This leads to scale as a result of use, which is automatically shown on the display. The machine must be adjusted to match the hardness of the water used. For this, please use the enclosed test stick.

➔ 1° water hardness on the German scale corresponds to 1.79° on the French scale.

The machine has 5 hardness settings to choose from. The indications on the display mean:

WATER HARDNESS LEVEL —	Water hardness function switched off
WATER HARDNESS LEVEL 1	German water hardness 1 – 7° French water hardness 1.79 – 12.53°
WATER HARDNESS LEVEL 2	German water hardness 8 – 15° French water hardness 14.32 – 26.85°
WATER HARDNESS LEVEL 3	German water hardness 16 – 23° French water hardness 28.64 – 41.14°
WATER HARDNESS LEVEL 4	German water hardness 24 – 30° French water hardness 42.96 – 53.7°

In the factory, the machine is set to hardness level 3. You can alter this setting. Proceed as follows:

- Switch the machine on with the ON/OFF  operating switch.
- **DISPLAY**: PLEASE WAIT
- Press the key PROG. (I) until an acoustic signal is heard.
- **DISPLAY**: AJUST COFFEE QUANTITY / SELECT PRODUCT
- Press the key ⊕ until the following report appears:
- **DISPLAY**: WATER HARDNESS LEVEL 3
- Press the key PROG., an acoustic signal is heard and the level set flashes.
- By pressing the key ⊖ or ⊕ you can set the required level. To store, press the key PROG. An acoustic signal is heard.
- Press the key EXIT (K).

9. Installing the Claris filter cartridge

➔ If the Claris filter cartridge is installed properly you don't have to de-scale your machine anymore. For more information on the Claris filter cartridge refer to the brochure "Claris. Hard on limescale. Gentle on your coffee machine."

9.1 Installing the filter

! First installation of a Claris filter cartridge must be carried out by a service engineer. Contact your service partner.

9.2 Replacing the filter

➔ After drawing off 50 liters the filter cartridge will be used up.

- **DISPLAY**: Replace water filter

1. Switch off your Impressa X7.
2. Press the following key combination (Fig. 11). NB: Press the keys at the same time.
 - **DISPLAY**: OK
3. Empty the water tank and install the filter cartridge together with the cartridge holder in the water tank, applying a gentle pressure downward. Move back the cartridge holder until it engages audibly (Fig. 12).
4. Fill the water tank with cold, fresh tap water and reinstall it.
5. After replacing the filter draw off 0.5 liters of water.

➔ The water may be slightly coloured (not harmful)

10. Coffee

10.1 Drawing off coffee / espresso

- **DISPLAY**: SELECT PRODUCT

- Place 1 or 2 cups, as necessary, under the coffee spout (4) and press the required selection switch. The pre-brew system (I.P.B.A.S[®]) moisturises the coffee powder, briefly interrupts the discharge and then starts the actual brewing procedure.

➔ You can interrupt the draw-off prematurely by pressing any of the coffee draw-off buttons. In order to obtain outstanding froth, you can adapt the coffee spout (4) individually to match the size of your cups.

10.2 Drawing off cappuccino

- **DISPLAY**: SELECT PRODUCT

- Put milk / Tetra Pak into a jug and immerse the cappuccino tube into the milk.
- Place 1 cup under the coffee spout and press the draw-off key . The machine firstly prepares the milk froth, then the coffee (Fig. 3).

➔ You can interrupt the milk froth and the coffee prematurely by pressing the draw-off key once more.

10 Min. after the draw-off of cappuccino, a rinsing is automatically started. The rinsing is announced in advance by an acoustic signal.

10.3 Drawing off pots of coffee

- **DISPLAY**: SELECT PRODUCT

- Place 1 pot under the coffee spout (4) and press the draw-off key (pot of coffee). Your pot of coffee is brewed in a number of cycles. The number of cycles is shown in the display.

➔ You can interrupt the draw-off prematurely at any time by pressing the draw-off key again.



11. Drawing off hot water

- **DISPLAY** : SELECT PRODUCT
- Place a cup under the pivoting nozzle (18) and press the draw-off key .
- **DISPLAY** : PORTION HOT WATER
- The draw-off of the programme portion of hot water stops automatically.

 You can interrupt the draw-off prematurely at any time by pressing the draw-off key again.

 When water is drawn off, there can be splattering at the beginning. The pivoting nozzle becomes hot. Avoid direct contact with the skin.

12. Drawing off steam

- **DISPLAY** : SELECT PRODUCT
- Place a cup with the liquid to be heated under the pivoting nozzle (18) and press the draw-off key .
- **DISPLAY** : STEAM ACTIVE
- To end the draw-off of steam, press the key .

 When steam is drawn off, there can be splattering at the beginning. The pivoting nozzle becomes hot. Avoid direct contact with the skin.

13. Drawing-off milk froth

- **DISPLAY** : SELECT PRODUCT
 - Pour milk / Tetra Pak into a jug and immerse the cappuccino tube into the milk.
 - Place 1 cup under the coffee spout (4) and press the draw-off key .
- The programme amount is prepared and stops automatically.

 You can interrupt the draw-off prematurely at any time by pressing the draw-off key again.

10 min. after the draw-off of milk, a rinsing is automatically started. The rinsing is announced in advance by an acoustic signal.

14. Switching the machine off



- Switch the machine off with the ON/OFF  operating switch. A rinsing is automatically started when the machine is switched off.

15. Programming



The following phases can be programmed:

- ▶ Grinding amount
- ▶ Temperature
- ▶ Amount of water
- ▶ Amount of milk
- ▶ Portion of hot water
- ▶ Water hardness
- ▶ Clock
- ▶ Machine on
- ▶ Machine off
- ▶ Draw-offs
- ▶ Language



15.1 Programming grinding amount

- Switch your machine on the with ON/OFF  operating switch.
- Press the key PROG. until an acoustic signal is heard.
- **DISPLAY** : ADJUST COFFEE QUANTITY / SELECT PRODUCT
- Press the required draw-off key.
- **DISPLAY** : (selected product)
–II..... +
- By pressing the key  or  you can determine the amount to be ground.
- To store, press the key PROG.
- **DISPLAY** : (selected product)
<: 100% >: 0%



You can determine the allocation of the grinder “left” or “right”.

- By pressing the key  or  you can change the values.
- To store, press the key PROG.
- **DISPLAY** : ADJUST COFFEE QUANTITY / SELECT PRODUCT
- Press the required draw-off key, the key  in order to reach the next phase or the key EXIT to quit the programming.





15.2 Programming Temperature

- **DISPLAY** : ADJUST TEMPERATURE / SELECT PRODUCT
- Press the required draw-off key.
- **DISPLAY** : (selected product)
STAND. TEMP.
- Select the required temperature with the keys  or  (high or standart)
- To store, press the key PROG.
- **DISPLAY** : ADJUST TEMPERATURE / SELECT PRODUCT
- Press the required draw-off key, the key  in order to reach the next phase or the key EXIT to quit the programming.

15.3 Programming amount of water

- **DISPLAY** : ADJUST WATER QUANTITY / SELECT PRODUCT
- Press the required draw-off key.
- **DISPLAY** : (selected product)
WATER 90 ML
- You can change the value by pressing the key  or .
- To store, press the key PROG.
- **DISPLAY** : ADJUST WATER QUANTITY / SELECT PRODUCT
- Press the required draw-off key, the key  in order to reach the next phase or the key EXIT to quit the programming.

15.4 Programming amount of milk

- **DISPLAY** : ADJUST MILK QUANTITY / SELECT PRODUCT
- Press the key  or 
- **DISPLAY** : (selected product)
10 SEC.
- You can alter the time by pressing the keys  or  (draw-off time from 3 – 60 sec.)
- To store, press the key PROG.
- **DISPLAY** : ADJUST MILK QUANTITY / SELECT PRODUCT
- Press the required draw-off key, the key  in order to reach the next phase or the key EXIT to quit the programming.

15.5 Programming portion of hot water

- Place a cup under the pivoting nozzle (18).
- **DISPLAY**: HOT WATER PORTION / **PRESS FOR HOT WATER**
- **DISPLAY**: ENOUGH HOT WATER ? / **PRESS FOR HOT WATER**
- **DISPLAY**: HOT WATER PORTION / **PRESS FOR HOT WATER**
- Press the key \oplus in order to reach the next phase or the key EXIT to quit the programming.

15.6 Programming water hardness

- **DISPLAY**: WATER HARDNESS
LEVEL 3
- Press the key PROG.
- You can set the water hardness by pressing the keys \oplus or \ominus .
- To store, press the key PROG.
- Press the key \oplus in order to reach the next phase or the key EXIT to quit the programming.

 To determine the water hardness, please read Chapter 8 “Setting the water hardness”

15.7 Programming CLOCK

Programming the clock is necessary if the function “Machine on” is used.

- **DISPLAY**: TIME.
—:—
- Press the key PROG.
- By pressing the keys \oplus or \ominus you can set the hours.
- To store, press the key PROG.
- By pressing the keys \oplus or \ominus you can set the minutes.
- To store, press the key PROG.
- Press the key \oplus in order to reach the next phase or the key EXIT to quit the programming.

15.8 Programming machine on

Programming the clock is necessary if the function “Machine on” is used.

- **DISPLAY**: UNIT
ON —:—
- Press the key PROG.
- By pressing the keys \oplus or \ominus you can set the hours.
- To store, press the key PROG.
- By pressing the keys \oplus or \ominus you can set the minutes.
- To store, press the key PROG.
- Press the key \oplus in order to reach the next phase or the key EXIT to quit the programming.

 The display —:— means that the function is switched off

15.9 Programming machine off

- **DISPLAY**: UNIT OFF
5.0 HRS.
- Press the key PROG.
- By pressing the keys \oplus or \ominus you can set the hours (switched off or 0.5 hrs. – 9 hrs.).
- To store, press the key PROG.
- Press the key \oplus in order to reach the next phase or the key EXIT to quit the programming.

15.10 Draw-offs

- **DISPLAY**: AUDIT TRAIL (total audit trail)
- Press the required draw-off key to inquire the draw-offs.
- Press the key \oplus in order to reach the next phase or the key EXIT to quit the programming.

 Draw-offs of steam cannot be inquired.

15.11 Programming language

- Press the key PROG.
- By pressing the keys \oplus or \ominus you can select the required language.
- To store, press the key PROG.
- Press the key \oplus in order to reach the next phase or the key EXIT to quit the programming.

16. Care and maintenance

16.1 Fill water

- **DISPLAY**: FILL WATER TANK
- When this display lights up, no more drawing-off is possible. Fill with water as described under Section 3.3.

 The water tank should be rinsed out every day and filled with fresh water.
If you use an automatic filling device, we recommend that you rinse the water tank out regularly and fill it up with fresh water.

16.2 Installation of an automatic filling device

Please read the operating instructions of the automatic filling device.

16.3 Empty grounds container

The grounds container collects the coffee grounds.

- **DISPLAY**: EMPTY DRAWER
- When this display lights up, no more draw-offs are possible and the grounds container must be emptied.
- Carefully remove the drip tray – there is water in it. Then remove the grounds container (Fig. 4).

16.4 Empty drip tray

- **DISPLAY**: EMPTY DRIP TRAY
- When this display lights up, no more draw-offs are possible and the drip tray must be emptied.
- Carefully remove the drip tray – there is water in it (Fig. 4).

16.5 Grounds container missing

- **DISPLAY**: DRAWER MISSING
- When this display lights up, the grounds container has not been inserted properly or is missing.

16.6 Drip tray missing

- **DISPLAY**: DRIP TRAY MISSING
- When this display lights up, the drip tray has not been inserted properly.

16.7 Fill beans

- **DISPLAY** : FILL COFFEE BEANS
- Fill with beans as described in Chapter 3.4.

➔ The display FILL COFFEE BEANS goes off after a draw-off of coffee.
We recommend that you clean the bean container out with a dry cloth from time to time before filling. For this, switch the machine **off**.

16.8 Removing foreign objects

- Switch your machine off with the ON/OFF  operating switch.
- Remove the plug from the power socket.
- Open the hinged door on the reverse of the machine (Fig. 5).
- Press the slides downwards (Fig. 6) and remove the bean container.
- Remove any beans with a vacuum cleaner.
- Position the spanner (Fig. 7).
- Turn the spanner in an anti-clockwise direction until the foreign object becomes loose.
- Remove remaining powder with a vacuum cleaner.
- Now replace the bean container and pull the slides to the front before closing the door. (Fig. 6).

16.9 Clean machine

- **DISPLAY** : CLEANING NECESSARY

After 220 draw-offs or 180 rinsings, the machine has to be cleaned. You can continue to draw off coffee and hot water/steam. We recommend that you clean the machine (Chapter 19) within the next few days.

➔ Carry out a cleaning (Chapter 19).

16.10 Machine scaled

- **DISPLAY** : DECALCIFYING NECESSARY

The machine recognises the necessity of de-scaling. You can continue to draw off coffee or hot water/steam. We recommend that you carry out the de-scaling (Chapter 20) within the next few days.

16.11 Clean contacts

- **DISPLAY** : EMPTY DRIP TRAY / CLEAN CONTACTS

The de-scaling residue in the area of the contacts must be removed. Please proceed as follows:

- Rinse the contact fasteners in trough (B) (Fig. 8) as well as the contacts (A) with hot water and washing-up liquid. Then additionally clean the contact fasteners in trough (B) with a brush.

16.12 General cleaning instructions

- Never use abrasive articles or corrosive chemicals to clean your machine.
- Wipe off the inside and outside of the casing with a soft, damp cloth.
- Clean the pivoting nozzle after every use.
- After heating milk, draw off a little hot water, in order to clean the pivoting nozzle from the inside.
- The water tank must be rinsed and filled with fresh water every day.



➔ If you see any visible scaling in the water tank, you can remove it with a customary de-scaling agent.

! Remove the water tank in order to clean it.



17. Cappuccino cleaning

! Carry out this cleaning **every day**.

Once the cleaning sequence has started, it must not be interrupted. It takes about 5 min.

- Switch the machine on with the ON/OFF  switch.
- Press the key  until an acoustic signal is heard.

■ **DISPLAY** : SELECT
CLEANING – +

- Press the key .
- **DISPLAY** : CAPPUCCINO CLEANING
- Press the key  again.
- **DISPLAY** : CLEANER FOR CAPPUCCINO /
PRESS CLEANING

! Place a vessel of at least 0.5 l under the coffee spout (4).

- Put about 25 cl of water into a vessel and add the cleaner. You can see the amount of cleaner on the label or the sheet accompanying the product in question. Immerse the cappuccino tube into it.

- Press the key .

■ **DISPLAY** : CAPPUCCINO CLEANING / PLEASE WAIT

- An acoustic signal is heard.

■ **DISPLAY** : WATER FOR CAPPUCCINO / PRESS CLEAN



! Fill a vessel with fresh water and immerse the cappuccino tube into it.

- Press the key .

■ **DISPLAY** : CAPPUCCINO CLEANING / PLEASE WAIT

18. Combined cleaning

Once the cleaning sequence has started, it must not be interrupted. It takes about 20 min.

- Switch the machine on with the ON/OFF  switch.
- Press the key  until an acoustic signal is heard.

■ **DISPLAY** : SELECT
CLEANING – +

- Press the key  2x.
- **DISPLAY** : ENTIRE CLEANING
- Press the key .

■ **DISPLAY** : EMPTY DRAWER / INSERT
TABLET (Fig. 10) /
CLEANER FOR CAPPUCCINO

- Place a sufficiently large vessel under the coffee spout .
- Put about 25 cl of water into a vessel and add the cleaner. You can see the amount of cleaner on the label or the sheet accompanying the product in question. Immerse the cappuccino tube into it.

- Press the key .

■ **DISPLAY** : ENTIRE CLEANING / PLEASE WAIT

■ **DISPLAY** : WATER FOR CAPPUCCINO / PRESS CLEAN

! Fill a vessel with fresh water and immerse the cappuccino tube into it.





- Press the key .

■ **DISPLAY** : COMBI CLEANING / PLEASE WAIT

■ **DISPLAY** : EMPTY DRAWER

19. Coffee cleaning

Once the cleaning sequence has started, it must not be interrupted. It takes about 15 min.



- Switch the machine on with the ON/OFF  switch.
- Press the key  until an acoustic signal is heard.
- **DISPLAY**: SELECT
CLEANING – +
- Press the key  3x.
- **DISPLAY**: COFFEE CLEANING
- Press the key 
- **DISPLAY**: EMPTY DRAWER / INSERT TABLET
(Fig. 10) /
PRESS CLEANING
- Place a sufficiently large vessel under the coffee spout (4).
- Press the key 
- **DISPLAY**: COFFEE CLEANING/ PLEASE WAIT
- **DISPLAY**: EMPTY DRAWER

20. Descaling

The machine has an integrated descaling programme. The process takes about 40 min.

 Once the descaling process has started, it must **not** be interrupted

If you use descaling agents containing acid, remove any splashes and drips on sensitive surfaces, in particular natural stone and wood surfaces, straight away or take corresponding safety precautions.

- **Switch the machine off with the ON/OFF  switch.**
- Press the key  until an acoustic signal is heard.
- **DISPLAY**: EMPTY DRIP TRAY
- **DISPLAY**: INSERT AGENT IN TANK / PRESS
DECALCIFYING
Dissolve 3 tablets completely in 0.7 litres of water in a vessel and pour the mixture into the empty water tank.

 Place two sufficiently large vessels under the pivoting nozzle (18) and the coffee spout.

- Press the key 
- **DISPLAY**: UNIT DECALCIFYING / PLEASE WAIT
- An acoustic signal is heard
- **DISPLAY**: EMPTY DRIP TRAY
- **DISPLAY**: FILL WATER TANK
- Place a vessel under the pivoting nozzle (18) and the coffee spout (4).
- **DISPLAY**: PRESS DESCALING
- **DISPLAY**: UNIT DECALCIFYING / PLEASE WAIT
- An acoustic signal is heard
- **DISPLAY**: EMPTY DRIP TRAY / CLEAN CONTACTS
(Chapter 16.4).

21. Disposal

For correct disposal, you should return your coffee machine to your dealer, Jura service centre or the firm of Jura.

22. Adjustments by the Jura service technician

 The following adjustments/alterations can only be done by a Jura service technician.

- Re-arrangement of the key occupancy of the coffee products
- Alteration of the cycles in “pot of coffee” draw-off
- Filter capacity

23. Tips for perfect coffee

Height-adjustable coffee spout

You can adjust the height of the coffee spout to the size of your cups.

Grinding

Please refer to Chapter 7 “Setting of grinder“

Pre-warm cups

You can warm the cups in advance with hot water or steam. The smaller the quantity of coffee, the more important the warming of the cups.

Sugar and cream

Heat is lost by stirring the contents of the cup. Adding milk or cream from the fridge considerably lowers the temperature of the coffee.

24. Messages

DISPLAY	Cause	Action
FILL WATER TANK	The tank is empty	Top up with water
	The water level display in the tank has jammed	Empty tank, rinse out and replace when it has been filled
	The tank is scaled; the water level display is jammed	Remove the tank, de-scale it, rinse well, fill and put in again
FILL COFFEE BEANS	The bean container is empty	Fill up with beans
	Although beans have been filled, the display does not go off	Draw off a cup of coffee. "FILL BEANS" only goes off after a draw-off
	A foreign body has got jammed	Remove the foreign body as described in Section 16.8 "Removing foreign objects"
EMPTY DRAWER	The grounds container is full	Remove the tray, empty the grounds container, replace the tray
	The display appears after only a few cups	Leave the machine switched on while the grounds container is emptied. The counter is only reset if the machine is switched on.
DRIP TRAY MISSING	The drip tray has not locked in properly	Position the tray correctly.
EMPTY DRIP TRAY	The drip tray is full	Carefully remove the tray, empty it, rinse it out and replace it
	The display does not go off despite the tray being emptied	Remove the tray, clean the metal contacts, see Chapter 16.11
CLEANING NECESSARY	220 draw-offs or 180 rinsings have been done	Carry out cleaning according to Chapter 19
	The display does not go off despite the cleaning	Do the cleaning once more; but do not add a cleaning tablet this time
DECALCIFYING NECESSARY	The machine must be de-scaled	Carry out de-scaling as described in Chapter 20
	The display does not go off despite the de-scaling	De-scale the machine again; this time only with water, without de-scaling agent
MALFUNCTION	Various causes	Call the office trader

25. Problems

Problems	Cause	Action
Coffee only drips out when drawing off	– powder too fine	– adjust grinder to a coarser grinding – run one or two rinse programmes. If the results are no better, clean the machine.
Coffee flow is stopped after the pre-brew	– not enough powder in the system	– draw off one cup of coffee
Grinder is very noisy	– foreign object in the grinder	– refer to Chapter 16.8
Not enough froth when frothing milk	– Cappuccino blocked	– carry out a Cappuccino cleaning (refer to Chapter 17)
Device cannot be switched on with the ON/OFF switch	– Main switch (Fig. 1/II) not switched on	– switch on
	– Flat not engaged properly	– close flap

If the messages or problems nevertheless still persist, please get in touch with your dealer or directly with the firm of Jura Elektroapparate AG.



26. Legal information

These operating instructions contain all the information necessary for the correct use, operation and maintenance of your machine. Understanding and complying with the directives contained in these operating instructions are essential for the use of the machine without risk and also for safety during operation and maintenance. These operating instructions cannot cover all imaginable uses of the machine.

We would further point out that the contents of these operating instructions in no way constitute a part of or amend any previous or existing contract, agreement or legal relationship. All obligations on the part of Jura Elektroapparate AG result from the sales agreement in question, which also contains the complete details of the valid warranty terms. These contractual warranty terms are neither extended nor limited in any way by the information contained in these operating instructions.

These operating instructions contain information protected by copyright. Photocopying or translation into another language without the prior written approval of Jura Elektroapparate AG are not admissible.

27. Technical specifications

Version «CH»

Voltage:	230 V AC
Output :	1500 W
Fuse:	10 A
Safety check:	
Energy consumption standby:	3 Wh
Energy consumption ready to make coffee:	approx. 51 Wh
Pump pressure:	2 x max. 15 bar
Water tank:	5,0 litres
Capacity, bean container:	2 x 260 gr.
Capacity, grounds container:	max. 40 port.
Cable length:	approx. 1,8 m
Weight:	17,3 kg
Dimensions (BxHxD):	42,5 x 52 x 50 cm

Version «International»

Voltage:	230 V AC
Voltage:	2200 W
Fuse:	15 A*
Safety check:	
Energy consumption standby:	3 Wh
Energy consumption ready to make coffee:	approx. 52 Wh
Pump pressure:	2 x max. 15 bar
Water tank:	5,0 litres
Capacity, bean container:	2 x 260 gr.
Capacity, grounds container:	max. 40 port.
Cable length:	approx. 1,8 m
Weight:	17,3 kg
Dimensions (BxHxD):	42,5 x 52 x 50 cm

Version «UL» 120 V AC

Voltage:	120 V AC
Voltage:	1500 W
Fuse:	15 A
Safety check:	

Version «UL» 220 V AC

Voltage:	220 V AC
Voltage:	2600 W
Fuse:	15 A*
Safety check:	

Energy consumption standby:	3 Wh
Energy consumption ready to make coffee:	120 V approx. 60 Wh 220 V approx. 52 Wh
Pump pressure:	2 x max. 15 bar
Water tank:	5,0 litres
Capacity, bean container:	2 x 260 gr.
Capacity, grounds container:	max. 40 port.
Cable length:	approx. 1,8 m
Weight:	17,3 kg
Dimensions (BxHxD):	42,5 x 52 x 50 cm

* During the preparation of draw-offs of coffee, steam or hot water can also be drawn off.