



IMPRESSA S9 AVANTGARDE

Instructions for use



IMPRESSA



Art. Nr. 64957

tel 0870 207 4831 | email mail@redmonkeycoffee.com

www.redmonkeycoffee.co.uk



tel 0870 207 4831 | email mail@redmonkeycoffee.com

www.redmonkeycoffee.co.uk

Legend:

- **DISPLAY** DISPLAY: serves as information.
- **DISPLAY** DISPLAY: please follow the instructions shown.

 = Note

 = Important

 = Tip

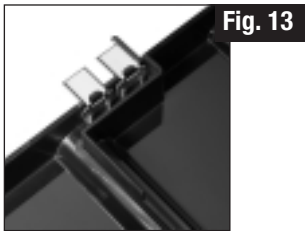
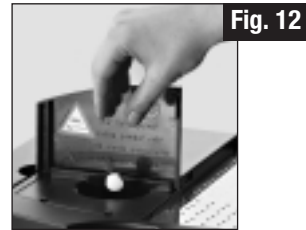
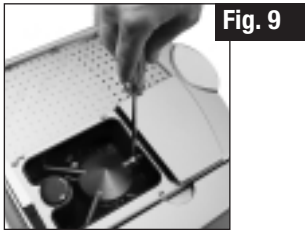
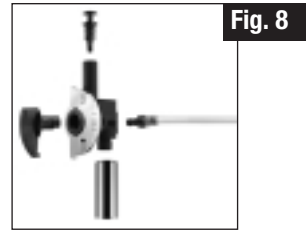
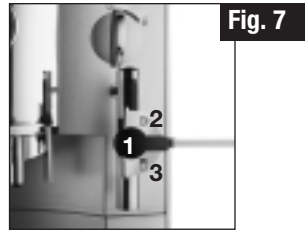
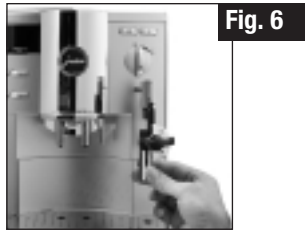
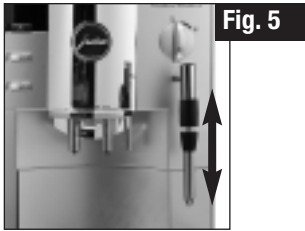
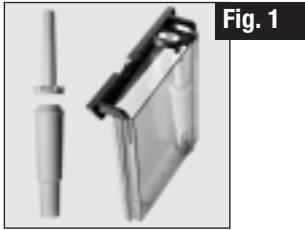

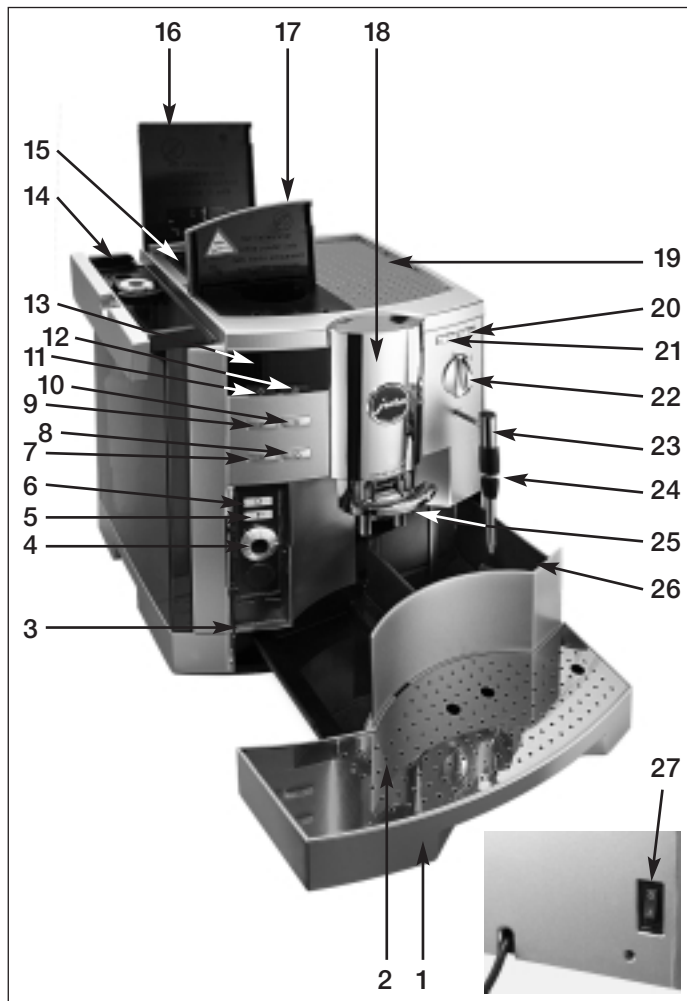

Description of the machine

- 1 Drip tray
- 2 Drip grate
- 3 Programming door
- 4 Rotary Switch
- 5 Selection key for pre-ground coffee
- 6 Coffee à la Carte key
- 7 1 Coffee key
- 8 2 Coffees key
- 9 1 Espresso key
- 10 2 Espressos key
- 11 ON / OFF key
- 12 Rinse key
- 13 Display dialog system
- 14 Water tank with handle
- 15 Aroma preservation cover
- 16 Bean tank cover
- 17 Lid for pre-ground coffee filler funnel
- 18 Height-adjustable coffee spout
- 19 Heatable cup shelf
- 20 Constant Steam key
- 21 Steam Portion key
- 22 Hot Water switch
- 23 Pivoting steam spout
- 24 2-stage frothing jet
- 25 Height-adjustable hot water spout
- 26 Coffee grounds bin
- 27 Power switch

Contents

1. Safety information	page 6	13.2 Programming your machine to the correct water hardness (only with FILTER NO)	page 14
1.1 Warnings	page 6	13.3 Maintenance	page 14
1.2 Precautions	page 6	13.4 Programming the amount of powder for coffee and espresso	page 14
2. Before you start using the IMPRESSA S9 AVANTGARDE	page 6	13.5 Setting the amount of water for coffee, espresso and coffee à la carte	page 15
2.1 Checking the mains voltage	page 6	13.6 Programming the temperature for coffee, espresso and coffee à la carte	page 15
2.2 Checking electrical fuse	page 6	13.7 Programming the water portion	page 16
2.3 Filling the water tank	page 7	13.8 Programming the steam portion	page 16
2.4 Filling the bean tank	page 7	13.9 Economy mode	page 17
2.5 Adjusting the grinding gear	page 7	13.10 Setting the time	page 17
3. First use	page 7	13.11 Programming the automatic switch-on time	page 18
3.1 Cup illumination	page 8	13.12 Programming the automatic switch-off time	page 19
4. Adjusting your machine to the water hardness	page 8	13.13 Programming the language	page 19
5. Using a Claris filter cartridge	page 8	13.14 Programming the display	page 19
5.1 Installing the filter	page 9	13.15 Information	page 20
5.2 Changing the filter	page 9	14. Maintenance	page 21
6. Rinsing the machine	page 10	14.1 Filling the water tank	page 21
7. Making coffee (1 espresso, 2 espressos, 1 coffee, 2 coffees)	page 10	14.2 Emptying the coffee grounds	page 21
7.1 Making coffee with pre-ground coffee powder	page 10	14.3 Emptying the drip tray	page 21
8. Making coffee à la carte	page 11	14.4 Drip tray missing	page 21
9. Making hot water	page 11	14.5 Filling the bean tank	page 21
10. Drawing off steam	page 12	14.6 Removing stones from the grinding gear	page 22
11. Frothing milk	page 12	14.7 Changing the filter	page 22
11.1 Frothing one portion of milk (with the 2-stage frothing nozzle)	page 12	14.8 Prompt to run cleaning cycle	page 22
11.2 Frothing milk (with the 2-stage frothing jet)	page 12	14.9 Prompt to run decalcifying cycle	page 22
11.3 Attaching the Professional-Cappuccino Frother to the IMPRESSA S9 AVANTGARDE	page 12	14.10 Emptying the system	page 22
11.4 Making cappuccino and hot milk with the Professional-Cappuccino Frother	page 13	14.11 General cleaning instructions	page 23
11.5 Cleaning the Professional-Cappuccino Frother and jet	page 13	15. Cleaning	page 23
12. Switching the IMPRESSA S9 AVANTGARDE off	page 13	16. Decalcifying	page 24
13. Programming	page 13	17. Disposal	page 25
13.1 Programming the filter	page 14	18. Tips for perfect coffee	page 26
		19. Problems	page 27
		20. Legal information	page 28
		21. Technical data	page 28

Before you begin

Congratulations on having bought this IMPRESSA S9 AVANTGARDE!

In order to ensure perfect operation of your IMPRESSA, carefully read this operating manual and keep it for future reference.

Should you need more information or meet with particular problems not specified in these operating instructions in sufficient detail, please contact JURA Elektroapparate AG directly or your local authorized dealer.



You will also find useful tips on operation and maintenance of the machine on our website at www.juraworld.com.

Don't forget to check out the knowledge builder – our animated operating instructions. LEO, our assistant, will take you through all the functions.

1. Safety information

1.1 Warnings

- Children are not aware of the dangers involved in using electric appliances. Therefore, never leave the machine unattended with unsupervised children around.
- The coffee machine must only be used by persons who know how to operate it.
- Never use a defective machine or a machine with a defective mains cable.
- Never immerse the IMPRESSA in water.

1.2. Precautions

- Never expose the coffee machine to weather (rain, snow, frost), never touch the machine when your hands are wet.
- Install the machine on a stable and level surface. Never place your machine on hot or warm surfaces (cooktops). Make sure the machine is set up in a place not accessible to children or pets.
- If you intend not to use the machine for a longer time (holidays, etc.), always turn off the power switch.
- Always turn off the power switch before cleaning the machine.
- When disconnecting the mains cable, never pull on the mains cable or the machine itself.
- Never repair or open the coffee machine yourself. Repairs may only be carried out by authorized service shops using original spare parts and accessories.
- The IMPRESSA is connected to the mains supply via a mains cable. Make sure nobody can trip over the mains cable. Keep out of reach of children and pets.
- Never put the coffee machine or parts of it into a dishwasher.
- Make sure to install the machine at a place with sufficient air circulation to prevent it from overheating.

2. Before you start using the IMPRESSA S9 AVANTGARDE

2.1 Checking the mains voltage

The coffee machine is preset to the correct mains voltage. Check if your local mains supply voltage complies with the information given on the type plate on the underside of the coffee machine.

2.2 Checking electrical fuse

The machine is designed for an electric current of 10 amperes. Check if the electrical fuse has sufficient capacity.

2.3 Filling the water tank

 Only use fresh, cold water. Never fill the water tank with milk, mineral water or other liquids.

- Take out the water tank and thoroughly rinse it out with cold tap water (Fig. 1).
- Then fill it with water and place it back into the coffee machine. Make sure the tank is installed correctly and that it engages properly.

2.4 Filling the bean tank

 To ensure your IMPRESSA will have a long service life and to avoid repairs, please note that the grinding gear is not suitable for coffee beans that have been treated with additives (e.g. sugar) during or after roasting. Coffee blends of this type may damage the machine's grinding gear. Repair costs resulting from such use are not subject to the terms of guarantee.

- Open the cover of the bean tank (Fig. 2) and remove the aroma preservation cover (15).
- Remove any dirt or foreign matter from the bean tank.
- Fill the bean tank with coffee beans (Fig. 2), replace the aroma preservation cover (15) and close the lid.

2.5 Adjusting the grinding gear





You can adjust the grinding gear to the roast of your coffee. We recommend that you use:

a finer setting → for a lighter roast
a coarser setting → for a darker roast

 The grinding degree may only be adjusted while the grinding gear is running.

- Open the lid of the bean tank (16).
- To adjust the grinding degree, turn the Rotary Switch (Fig. 2) to the required position.
The smaller the dots, the finer the grind
The larger the dots, the coarser the grind

3. First use

- Press the power switch (27) on the back (bottom left) of the machine (Fig. 3).
- The ON / OFF key  (11) lights up to indicate that the machine has been switched on with the power switch.
- Switch the machine on using the ON / OFF key  (11). The light of the ON / OFF key goes off.
- Open the programming door (3).
- **DISPLAY** LANGUAGE
ENGLISH
- Turn the Rotary Switch (4) until the required language is displayed.
- Example:
■ **DISPLAY** LANGUAGE
ENGLISH
- Confirm your selection by pressing the Rotary Switch (4).
- **DISPLAY** FILL SYSTEM / PRESS STEAM
- Place a receptacle under the 2-stage frothing jet (24) and press one of the Steam keys  .
- The system now fills up automatically. The Rinse key flashes while the system fills up . A little water will leak from the frothing jet.
- **DISPLAY** SYSTEM FILLING
- **DISPLAY** HEATING UP
- **DISPLAY** PRESS RINSE

- Place a cup under the height-adjustable coffee spout (18).
- Press Rinse .
- **DISPLAY** MACHINE RINSING
- Now the water lines are flushed with fresh water. A little water will leak from the coffee spout (18).
- **DISPLAY** SELECT PRODUCT
- You can now make a product of your choice by pressing the corresponding key.



If FILL BEANS appears on the display, press one of the coffee product keys again. The grinder is not yet completely filled with coffee beans.



For a perfect frothing result, adjust the height-adjustable coffee spout to the size of your cup (Fig. 4).

3.1 Cup illumination

The cup illumination puts your coffee in a good light, making it a treat for the eyes as well.

When you switch on the IMPRESSA or press any key, the cup illumination is activated for 1 minute.

4. Adjusting your machine to the water hardness



The IMPRESSA heats up water. As a result, calcification occurs during normal use. This is indicated automatically. The IMPRESSA must therefore be adjusted to the hardness of the water used. Use the supplied test sticks to determine the water hardness or contact your local waterworks.





1° German hardness is equivalent to 1.79° French hardness.



The water hardness programming step is no longer displayed if the filter is activated.

The IMPRESSA is preset to 16°dH. This setting can be changed. To do so, proceed as follows:



- **DISPLAY** SELECT PRODUCT
- Open the programming door (3). Press the Rotary Switch (4) until you hear an acoustic signal.
- **DISPLAY** FILTER NO
- Turn the Rotary Switch (4) until the following message is displayed:
- **DISPLAY** HARDNESS
16°dH
- Now press the Rotary Switch (4) to start programming.
- **DISPLAY** 16°dH

- Now turn the Rotary Switch (4) until the required water hardness is set.
- **DISPLAY** 20°dH (example)

- Confirm the selected setting by pressing the Rotary Switch (4).
- **DISPLAY** HARDNESS
20°dH (example)
- Now turn the Rotary Switch (4) until the following message is displayed:
- **DISPLAY** EXIT
- Now press the Rotary Switch (4) to leave the programming mode.
- **DISPLAY** SELECT PRODUCT

5. Using a Claris filter cartridge



When using the Claris filter cartridge correctly, decalcifying your IMPRESSA will no longer be necessary. For more information on the Claris filter cartridge refer to the brochure “Claris. Hard on limescale. Gentle on your coffee machine.”

5.1 Installing the filter

- Open the programming door (3). Press the Rotary Switch (4) until you hear an acoustic signal.
- **DISPLAY** FILTER
NO
- Now press the Rotary Switch (4) to start programming.
- Turn the Rotary Switch (4) until the following message is displayed:
 - **DISPLAY** FILTER
YES
 - Confirm your setting by pressing the Rotary Switch (4).
 - **DISPLAY** INSERT
FILTER / PRESS STEAM
 - Take out the water tank (14). Empty out any remaining water. Fold up the cartridge holder (Fig. 1). Attach the extension piece (contained in the Welcome Pack) to the top of the Claris filter cartridge. Now insert the filter cartridge in the water tank, applying gentle pressure (Fig. 1)
 - Close the cartridge holder until it engages audibly.
 - Fill the water tank (14) with cold, fresh tap water and place it back into the machine.
 - Place a sufficiently large receptacle (min. 0.5 litres) under the pivoting nozzle (23) and press one of the Steam keys   to start the filter rinsing process.
 - **DISPLAY** FILTER RINSING
 - Filter rinsing stops automatically.
 - **DISPLAY** SELECT PRODUCT
- ➔ You have now activated the filter. The programming step for adjusting your machine to the correct water hardness is therefore no longer displayed.







The water might be slightly discoloured (no hazard to health).

5.2 Changing the filter



After 50 litres of water the filter cartridge will need to be replaced. The display will prompt you to change the filter.

- **DISPLAY** SELECT PRODUCT / CHANGE FILTER
- The Rinse key  lights up. Press Rinse .
- **DISPLAY** INSERT FILTER / PRESS STEAM
- Remove the water tank (14) from the IMPRESSA. Empty out any remaining water. Fold up the cartridge holder (Fig. 1). Attach the extension piece to the top of the Claris filter cartridge. Now insert the filter cartridge in the water tank, applying gentle pressure (Fig. 1)
- Close the cartridge holder until it engages audibly.
- Fill the water tank (14) with cold, fresh tap water and place it back into the machine.
- Place a sufficiently large receptacle (min. 0.5 litres) under the pivoting nozzle (23) and press one of the Steam keys   to start the filter rinsing process.
- **DISPLAY** FILTER RINSING
- Filter rinsing stops automatically.
- **DISPLAY** SELECT PRODUCT
- ➔ You can also trigger a change of filter manually from the Maintenance menu at any point in time (only if the filter has been activated) - see Chapter 13.3.

6. Rinsing the machine

 If the coffee machine is switched off and has cooled down, you will be prompted to start a rinsing cycle when switching the machine back on. The rinsing cycle starts automatically when you switch the machine off.

■ **DISPLAY** PRESS RINSE

■ Place a cup under the coffee spout (18).

■ Press Rinse .

■ **DISPLAY** MACHINE RINSING





■ **DISPLAY** SELECT PRODUCT

 You can also trigger a rinsing cycle manually from the Maintenance menu at any point in time (see Chapter 13.3).

7. Making coffee

(1 espresso, 2 espressos, 1 coffee, 2 coffees)

■ **DISPLAY** SELECT PRODUCT

■ Place 1 or 2 cups (as required) under the coffee spout (18) and press a key of your choice , , , . The pre-brewing process (I.P.B.A.S.) moistens the coffee powder, briefly interrupts the flow of hot water and then begins with the actual brewing process.

■ **DISPLAY** 1 ESPRESSO (example)
NORMAL (example)

■ The coffee brewing process stops automatically as soon as the set amount of water has run through.

■ **DISPLAY** SELECT PRODUCT

 To stop the brewing process prematurely, press any of the product keys.



You can change the amount of water while the machine is brewing coffee. Open the programming door. Turn the Rotary Switch (4) until the display indicates the required amount (ML). The amount of water can be selected in increments of 5 ML.



The amounts given in ML are approximate values and may vary from the effective quantity.

7.1. Making coffee with pre-ground coffee powder



Never use water-soluble instant coffee.

■ **DISPLAY** SELECT PRODUCT

■ Place 1 or 2 cups (as required) under the coffee spout (18) and open the programming door (3). Press the selection key for pre-ground coffee .

■ **DISPLAY** FILL
POWDER / SELECT PRODUCT

■ Now fill 1 or 2 level scoops of pre-ground coffee into the filler funnel for pre-ground coffee (17).

■ Then press a product key of your choice.

■ **DISPLAY** 1 ESPRESSO (example)
POWDER



■ The coffee brewing process stops automatically as soon as the set amount of water has run through.

■ **DISPLAY** SELECT PRODUCT



To stop the brewing process prematurely, press any of the product keys.

 We recommend always using powder from fresh coffee beans or pre-ground, vacuum-packed coffee. Never fill in more than 2 scoops of powder. The filler funnel is no storage tank. Make sure the coffee powder you use is not too fine. This may block the system and cause the coffee only to drip out of the coffee spout.

 If you have pressed the selection key  unintentionally, press any of the product keys to cancel your selection.

 You can change the amount of water while the machine is brewing coffee. To do so, turn the Rotary Switch (4) until the display indicates the required amount (ML). The amount of water can be selected in increments of 5 ML.

 The amounts given in ML are approximate values and may vary from the effective quantity.

8. Making coffee à la carte

■ **DISPLAY** SELECT PRODUCT

■ Place 1 cup under the coffee spout (18) and open the programming door (3). Press the Coffee à la Carte key .

■ **DISPLAY** A LA CARTE
XMILD

■ Turn the Rotary Switch (4) until the display indicates the desired coffee strength and press the Rotary Switch (4) to make the coffee. The pre-brewing process (I.P.B.A.S.) moistens the coffee powder, briefly interrupts the flow of hot water and then begins with the actual brewing process.

■ **DISPLAY** A LA CARTE
XSTRONG (example)

■ The coffee brewing process stops automatically as soon as the set amount of water has run through.

■ **DISPLAY** SELECT PRODUCT

 To stop the brewing process prematurely, press any of the product keys.

 You can change the amount of water while the machine is brewing coffee. To do so, turn the Rotary Switch (4) until the display indicates the required amount (ML). The amount of water can be selected in increments of 5 ML.

 The amounts given in ML are approximate values and may vary from the effective quantity.

9. Making hot water

■ **DISPLAY** SELECT PRODUCT

■ Place 1 cup or 1 glass under the hot water spout (25) and turn the Hot Water switch (22) to .

■ **DISPLAY** WATER
PORTION

■ The machine stops dispensing water automatically as soon as the set amount of water has been dispensed.

■ **DISPLAY** CLOSE TAP

■ Turn the switch (22) back to .

■ **DISPLAY** SELECT PRODUCT

 To stop the process prematurely, turn the switch (22) back to .

 You can also change the amount of water set while the machine is brewing coffee. Open the programming door. Turn the Rotary Switch (4) until the display indicates the required amount (ML). The amount of water can be selected in increments of 5 ML.

 The amounts given in ML are approximate values and may vary from the effective quantity.

10. Drawing off steam





Steam can be used for heating liquids and frothing milk for cappuccino. When heating liquids, make sure the 2-stage frothing jet (24) is pushed up. Push the frothing jet down (Fig. 4) to heat liquids.



A small amount of water leaks from the jet when you start frothing. This does not affect the result, e.g. when frothing milk.



There might be some initial splashing when drawing off steam. The steam jet gets hot. Avoid direct contact with the skin!



- **DISPLAY** SELECT PRODUCT
- Place a cup under the pivoting spout (23) and dip the 2-stage frothing jet (24) in the milk to be frothed or the liquid to be heated.
- Press the Steam Portion key .
- **DISPLAY** STEAM PORTION
- You can stop the process any time by pressing the Steam Portion key .
- **DISPLAY** SELECT PRODUCT



You can set the duration of drawing off steam in 1-second increments with the Rotary Switch (4).

11. Frothing milk



The IMPRESSA is ready to froth milk when both Steam key lights   light up constantly.

If the lights are off, press one of the two Steam keys  .

11.1 Frothing one portion of milk (with the 2-stage frothing jet)

- **DISPLAY** SELECT PRODUCT
- Pour milk into a jug or similar receptacle.
- Dip the 2-stage frothing jet (24) into the milk and press the  key.
- **DISPLAY** STEAM PORTION
- The steam dispensing process stops automatically.

11.2 Frothing milk (with the 2-stage frothing jet)

- **DISPLAY** SELECT PRODUCT
- Pour milk into a jug or similar receptacle.
- Dip the 2-stage frothing jet (24) into the milk and press the  key.
- **DISPLAY** DRAW OFF STEAM
- When you have frothed the milk to your liking, press the  key again.

11.3 Attaching the Professional-Cappuccino Frother to the IMPRESSA S9 AVANTGARDE

- Remove the 2-stage frothing jet (24).
- Now attach the Professional-Cappuccino Frother (Fig. 6).
- Press the hose into one side of the opening behind the dial (Fig. 7).





The supplied “Deluxe” milk pitcher is suited for drawing in the milk.

11.4 Making cappuccino and hot milk with the Professional-Cappuccino Frother

- Fill the milk pitcher with milk or dip the milk hose directly into the milk.
- Place a cup under the Professional-Cappuccino Frother.
- Press the Steam Portion key .
- **DISPLAY** STEAM PORTION
- The machine will froth or heat milk according to the time you programmed (see “Programming the steam portion”, Chapter 13.8)
- **For cappuccino, turn the selector switch (1, Fig. 7) to (2).**
- **For hot milk, turn the selector switch (1, Fig. 7) to (3).**
- Now place the cup with the cappuccino froth or hot milk under the coffee spout (18) and make a coffee of your choice.

11.5 Cleaning the Professional-Cappuccino Frother and jet

-  After heating or frothing milk, you should clean the Professional-Cappuccino Frother. We recommend cleaning it on a daily basis.
-  Your IMPRESSA will not prompt you to clean the Professional-Cappuccino Frother.
- Fill water into a receptacle and dip the milk hose into it.
- Draw steam until the water / steam from the Frother runs clear.
-  We also recommend regularly disassembling the Frother and rinsing it under running water.
- Remove the Professional-Cappuccino Frother from the IMPRESSA and take it apart as shown in Fig. 8.

- Thoroughly rinse all the parts of the Professional-Cappuccino Frother under running water.
- Re-assemble the Professional-Cappuccino Frother and attach it to your IMPRESSA.

12. Switching the IMPRESSA S9 AVANTGARDE off

Switching the IMPRESSA off causes the coffee spout to be rinsed first. Therefore, please make sure to place a suitable receptacle under the coffee spout (18).

- **DISPLAY** SELECT PRODUCT
- Switch the IMPRESSA off with the ON / OFF key  (11).
- **DISPLAY** MACHINE RINSING
- The coffee spout (18) is rinsed.

13. Programming

-  The IMPRESSA leaves the factory with a number of default settings that allow you to make coffee without having to program the machine first. You can, however, adjust various parameters to make the coffee suit your personal taste.

The following parameters can be adjusted:

- Filter
- Water hardness
- Rinse
- Powder quantity
- Water quantity
- Temperature
- Water portion
- Steam portion
- Economy mode
- Time
- Automatic switch-on time
- Automatic switch-off time
- Language

- Display
- Information (to be viewed only)

13.1 Programming the filter

Please refer to Chapter 5 “Using the Claris filter cartridge”.

13.2 Programming your machine to the correct water hardness (only with FILTER NO)

Please refer to Chapter 4 “Adjusting your machine to the water hardness”.

13.3 Maintenance

You can activate the following maintenance functions from this program item:

RINSE MACHINE, CLEAN MACHINE, DE-SCALE MACHINE, CHANGE FILTER.

“DE-SCALE machine” is not displayed if you are using a Claris filter and the filter is set to “YES”.

“CHANGE FILTER” is not displayed if you are not using a Claris filter and the filter is set to “NO”.

- **DISPLAY** SELECT PRODUCT
- Open the programming door (3). Press the Rotary Switch (4) until you hear an acoustic signal.
- **DISPLAY** FILTER
NO or YES
- Turn the Rotary Switch (4) until the following message is displayed:
- **DISPLAY** RINSE
- Now press the Rotary Switch (4) to start programming.
- **DISPLAY** RINSE
MACHINE

- Turn the Rotary Switch (4) until the required maintenance function (for selection see above) is displayed. Press the Rotary Switch (4) to activate the function.



The Maintenance menu closes automatically after 5 seconds if no function is selected.

13.4 Programming the amount of powder for coffee and espresso



You can adjust the amount of powder for coffee and espresso separately.

- **DISPLAY** SELECT PRODUCT
- Open the programming door (3). Press the Rotary Switch (4) until you hear an acoustic signal.
- **DISPLAY** FILTER
NO or YES
- Turn the Rotary Switch (4) until the following message is displayed:
- **DISPLAY** POWDER
QUANTITY
- Now press the Rotary Switch (4) to start programming.
- **DISPLAY** SELECT
PRODUCT
- Then press a product key of your choice.
- **DISPLAY** NORMAL (example)
- ■■■ _ _ _ +
- Now turn the Rotary Switch (4) until the required amount of powder is set.
- **DISPLAY** STRONG (example)
- ■■■■ _ _ +
- Confirm the selected setting by pressing the Rotary Switch (4).

- **DISPLAY** POWDER
QUANTITY

- Now turn the Rotary Switch (4) until the following message is displayed:

- **DISPLAY** EXIT

- Now press the Rotary Switch (4) to leave the programming mode.

- **DISPLAY** SELECT PRODUCT

13.5 Setting the amount of water for coffee, espresso and coffee à la carte

The system's basic settings include pre-defined amounts of water (coffee 130 ml, espresso 60 ml, 2 coffees 260 ml, 2 espressos 120 ml, coffee à la carte 145 ml). However, these can be modified as required.

- **DISPLAY** SELECT PRODUCT

- Open the programming door (3). Press the Rotary Switch (4) until you hear an acoustic signal.

- **DISPLAY** FILTER
NO or YES

- Turn the Rotary Switch (4) until the following message is displayed:

- **DISPLAY** WATER
QUANTITY

- Press the Rotary Switch (4) to activate the program item.

- **DISPLAY** SELECT
PRODUCT

- Press a product key of your choice.

- **DISPLAY** 1 ESPRESSO (example)
60 ML

- Turn the Rotary Switch (4) to adjust the amount of water and then confirm your setting by pressing the Rotary Switch (4).

- **DISPLAY** WATER
QUANTITY

- Turn the Rotary Switch (4) until the following message is displayed:

- **DISPLAY** EXIT

- Press the Rotary Switch (4) to leave the programming mode.

- **DISPLAY** SELECT PRODUCT

13.6 Programming the temperature for coffee, espresso and coffee à la carte

 You can adjust the temperature for each type of coffee separately. The temperature can be set to 2 different levels (NORMAL, HIGH).

- **DISPLAY** SELECT PRODUCT

- Open the programming door (3). Press the Rotary Switch (4) until you hear an acoustic signal.

- **DISPLAY** FILTER
NO or YES

- Turn the Rotary Switch (4) until the following message is displayed:

- **DISPLAY** TEMPERATURE

- Now press the Rotary Switch (4) to start programming.

- **DISPLAY** SELECT PRODUCT

- Then press a product key of your choice.

- **DISPLAY** TEMPERATURE
NORMAL (example)

- Now turn the Rotary Switch (4) until the required temperature is set.

- **DISPLAY** TEMPERATURE
HIGH (example)

- Confirm the selected setting by pressing the Rotary Switch (4).
- **DISPLAY** TEMPERATURE
- Now turn the Rotary Switch (4) until the following message is displayed:
- **DISPLAY** EXIT
- Now press the Rotary Switch (4) to leave the programming mode.
- **DISPLAY** SELECT PRODUCT

13.7 Programming the water portion

The system's basic settings include a pre-defined amount of water (225 ml). However, this amount can be modified as required.

- **DISPLAY** SELECT PRODUCT
- Open the programming door (3). Press the Rotary Switch (4) until you hear an acoustic signal.
- **DISPLAY** FILTER
NO or YES
- Turn the Rotary Switch (4) until the following message is displayed:
- **DISPLAY** WATER
PORTION
- Press the Rotary Switch (4) to activate the program item.
- **DISPLAY** PORTION
225 ML (example)
- Turn the Rotary Switch (4) to adjust the amount of water and then confirm your setting by pressing the Rotary Switch (4).
- **DISPLAY** WATER
PORTION
- Turn the Rotary Switch (4) until the following message is displayed:

- **DISPLAY** EXIT
- Press the Rotary Switch (4) to leave the programming mode.
- **DISPLAY** SELECT PRODUCT

13.8 Programming the steam portion

The system's basic settings include a pre-defined steam portion (20 sec.). However, this amount can be modified as required.

- **DISPLAY** SELECT PRODUCT
- Open the programming door (3). Press the Rotary Switch (4) until you hear an acoustic signal.
- **DISPLAY** FILTER
NO or YES
- Turn the Rotary Switch (4) until the following message is displayed:
- **DISPLAY** STEAM
PORTION
- Press the Rotary Switch (4) to activate the program item.
- **DISPLAY** PORTION
20 SEC (example)
- Turn the Rotary Switch (4) to modify the steam portion and then confirm your setting by pressing the Rotary Switch (4).
- **DISPLAY** STEAM
PORTION
- Turn the Rotary Switch (4) until the following message is displayed:
- **DISPLAY** EXIT
- Press the Rotary Switch (4) to leave the programming mode.
- Display: SELECT PRODUCT

13.9 Economy mode



You can set your machine to various power saving modes.

- **DISPLAY** SELECT PRODUCT
- Open the programming door (3). Press the Rotary Switch (4) until you hear an acoustic signal.
- **DISPLAY** FILTER
NO or YES
- Turn the Rotary Switch (4) until the following message is displayed:
- **DISPLAY** ECONOMY
MODE -
- Now press the Rotary Switch (4) to start programming.
- **DISPLAY** ECONOMY
MODE -
- Now turn the Rotary Switch (4) until the required economy mode is displayed.
- **DISPLAY** ECONOMY
MODE 2 (example)
- Confirm the selected setting by pressing the Rotary Switch (4).
- **DISPLAY** ECONOMY
MODE 2 (example)
- Now turn the Rotary Switch (4) until the following message is displayed:
- **DISPLAY** EXIT
- Now press the Rotary Switch (4) to leave the programming mode.
- **DISPLAY** SELECT PRODUCT

Economy mode –

Selecting this level puts the IMPRESSA in constant stand-by mode.

This setting allows you to make any of the products without having to wait for the machine to heat up.



Select this setting if you want to make a lot of coffees with hot or frothed milk and do not want to wait for the machine to heat up first.

Economy mode 1

Selecting this level puts the IMPRESSA in constant stand-by mode for making coffee. The machine is heated up separately if you need steam for hot or frothed milk.



Select this setting if you make mostly black coffees and are prepared to wait for approx. 1 minute before being able to draw steam.

Economy mode 2

Selecting this level does not put the IMPRESSA in stand-by mode (economy temperature). The machine heats up each time you make coffee or need to draw steam.

The IMPRESSA switches to economy temperature 5 minutes after you last used it.



Select this setting if you make very few coffees (with or without milk) and are prepared to wait for approx. 30 seconds for the machine to get ready.

13.10 Setting the time

You must program the time if you want to use the automatic switch-on function.

- **DISPLAY** SELECT PRODUCT
- Open the programming door (3). Press the Rotary Switch (4) until you hear an acoustic signal.
- **DISPLAY** FILTER
NO or YES
- Turn the Rotary Switch (4) until the following message is displayed:
- **DISPLAY** TIME
—:—
- Now press the Rotary Switch (4) to start programming.
- **DISPLAY** TIME
—:—
- Turn the Rotary Switch (4) to set the hours.
- **DISPLAY** TIME
13:00 (example)
- Press the Rotary Switch (4) to confirm the hours and to activate the minutes.
- **DISPLAY** TIME
13:00
- Turn the Rotary Switch (4) to set the minutes.
- **DISPLAY** TIME
13:50 (example)
- Press the Rotary Switch (4) to confirm the minutes.
- **DISPLAY** TIME
13:50
- Now turn the Rotary Switch (4) until the following message is displayed:
- **DISPLAY** EXIT
- Now press the Rotary Switch (4) to leave the programming mode.
- **DISPLAY** SELECT PRODUCT

13.11 Programming the automatic switch-on time

You must program the time if you want to use the automatic switch-on function.

- **DISPLAY** SELECT PRODUCT
- Open the programming door (3). Press the Rotary Switch (4) until you hear an acoustic signal.
- **DISPLAY** FILTER
NO or YES
- Turn the Rotary Switch (4) until the following message is displayed:
- **DISPLAY** UNIT ON
—:—
- Now press the Rotary Switch (4) to start programming.
- **DISPLAY** UNIT ON
—:—
- Turn the Rotary Switch (4) to set the hours.
- **DISPLAY** UNIT ON
07:00 (example)
- Press the Rotary Switch (4) to confirm the hours and to activate the minutes.
- **DISPLAY** UNIT ON
07:00
- Turn the Rotary Switch (4) to set the minutes.
- **DISPLAY** UNIT ON
07:15 (example)
- Press the Rotary Switch (4) to confirm the minutes.
- **DISPLAY** UNIT ON
07:15
- Now turn the Rotary Switch (4) until the following message is displayed:
- **DISPLAY** EXIT

- Now press the Rotary Switch (4) to leave the programming mode.
- **DISPLAY** SELECT PRODUCT

 If the IMPRESSA is switched off with the power switch (27), you will need to set the time again next time you switch the machine on. The machine will prompt you to do so.

13.12 Programming the automatic switch-off time

- **DISPLAY** SELECT PRODUCT
- Open the programming door (3). Press the Rotary Switch (4) until you hear an acoustic signal.
- **DISPLAY** FILTER
NO or YES
- Turn the Rotary Switch (4) until the following message is displayed:
- **DISPLAY** OFF AFTER
5 HRS
- Now press the Rotary Switch (4) to start programming.
- **DISPLAY** OFF AFTER
5 HRS
- Turn the Rotary Switch (4) to set the switch-off time.
- **DISPLAY** OFF AFTER
4 HRS (example)
- Confirm the set switch-off time by pressing the Rotary Switch (4).
- **DISPLAY** OFF AFTER
4 HRS
- Now turn the Rotary Switch (4) until the following message is displayed:
- **DISPLAY** EXIT
- Now press the Rotary Switch (4) to leave the programming mode.
- **DISPLAY** SELECT PRODUCT

13.13 Programming the language

- **DISPLAY** SELECT PRODUCT
- Open the programming door (3). Press the Rotary Switch (4) until you hear an acoustic signal.
- **DISPLAY** FILTER
NO or YES
- Turn the Rotary Switch (4) until the following message is displayed:
- **DISPLAY** LANGUAGE
ENGLISH
- Now press the Rotary Switch (4) to start programming.
- **DISPLAY** LANGUAGE
ENGLISH
- Turn the Rotary Switch (4) to set the language.
- **DISPLAY** LANGUAGE
ENGLISH (example)
- Confirm your selection by pressing the Rotary Switch (4).
- **DISPLAY** LANGUAGE
ENGLISH
- Now turn the Rotary Switch (4) until the following message is displayed:
- **DISPLAY** EXIT
- Now press the Rotary Switch (4) to leave the programming mode.
- **DISPLAY** SELECT PRODUCT

13.14 Programming the display

 This program item allows you to change the time format from 24 hrs. to AM/PM and the units from ml (millilitres) to oz (ounces).

- **DISPLAY** SELECT PRODUCT



- Open the programming door (3). Press the Rotary Switch (4) until you hear an acoustic signal.
- **DISPLAY** FILTER
NO or YES
- Turn the Rotary Switch (4) until the following message is displayed:
- **DISPLAY** DISPLAY
24HRS / ML
- Now press the Rotary Switch (4) to start programming.
- **DISPLAY** DISPLAY
24HRS / ML
- Turn the Rotary Switch (4) to change the time format.
- **DISPLAY** DISPLAY
AM/PM / ML
- Confirm your selection by pressing the Rotary Switch (4).
- **DISPLAY** DISPLAY
AM/PM / ML
- Turn the Rotary Switch (4) to change the unit of measurement.
- **DISPLAY** DISPLAY
AM/PM / OZ
- Confirm your selection by pressing the Rotary Switch (4).
- **DISPLAY** DISPLAY
AM/PM / OZ
- Turn the Rotary Switch (4) until the following message is displayed:
- **DISPLAY** EXIT
- Now press the Rotary Switch (4) to leave the programming mode.
- **DISPLAY** SELECT PRODUCT

13.15 Information



This program item enables you to check the number of products you made and how often you selected a specific function.

- **DISPLAY** SELECT PRODUCT
- Open the programming door (3). Press the Rotary Switch (4) until you hear an acoustic signal.
- **DISPLAY** FILTER
NO or YES
- Turn the Rotary Switch (4) until the following message is displayed:
- **DISPLAY** INFO
- Now press the Rotary Switch (4) to access the Information menu.
- **DISPLAY** 1 ESPRESSO
1000 (example)
- Turn the Rotary Switch (4) to display how often you made 2 espressos, 1 coffee, 2 coffees, coffee à la carte, powder, water and steam.
- Finally, the number of cleaning and decalcifying cycles and filter changes are displayed.
- To exit the information program, press the Rotary Switch (4).
- **DISPLAY** INFO
- Now turn the Rotary Switch (4) until the following message is displayed:
- **DISPLAY** EXIT
- Now press the Rotary Switch (4) to leave the programming mode.
- **DISPLAY** SELECT PRODUCT

14 Maintenance

14.1 Filling the water tank

- **DISPLAY** FILL
WATER TANK

 If this information is displayed, the machine will no longer make coffee. Refill water as described in Chapter 2.3.

- **DISPLAY** SELECT PRODUCT

 The water tank should be rinsed out and filled with fresh water daily. Always use fresh, cold water. Never fill the water tank with milk, mineral water or other liquids.

14.2 Emptying the coffee grounds

- **DISPLAY** EMPTY
GROUND

 If this information is displayed, the machine will no longer make coffee. However, the machine will still dispense hot water and steam. Empty the coffee grounds bin (26).

- Carefully take out the drip tray (1) - which contains water - and the integrated coffee grounds bin.

- **DISPLAY** TRAY
MISSING

- Place the empty, clean drip tray (1) and integrated coffee grounds bin back into the IMPRESSA. (The tray must be removed from the machine for at least 10 seconds).

- **DISPLAY** SELECT PRODUCT

14.3 Emptying the drip tray

- **DISPLAY** EMPTY
TRAY

 If this information is displayed, the machine will no longer dispense coffee or steam, and the tray must be emptied.

- Carefully take out the drip tray (1) – which contains water – and the integrated coffee grounds bin.

- **DISPLAY** TRAY
MISSING

- Place the empty, clean drip tray (1) and integrated coffee grounds bin back into the IMPRESSA.

- **DISPLAY** SELECT PRODUCT

14.4 Drip tray missing

- **DISPLAY** TRAY
MISSING

 If this information is displayed, the machine will no longer make coffee. The drip tray (1) and integrated coffee grounds bin have not been installed or not been installed properly.

- Insert the drip tray (1) and integrated coffee grounds bin.

- **DISPLAY** SELECT PRODUCT

14.5 Filling the bean tank

- **DISPLAY** FILL
BEANS

 If this information is displayed, the machine will no longer make coffee. However, the machine will still dispense hot water and steam. Refill beans as described in Chapter 2.4.

- **DISPLAY** SELECT PRODUCT

14.6 Removing stones from the grinding gear

- Switch the machine off using the ON / OFF key  (11).
- Turn the power switch (27) off.
- Open the lid of the bean tank (16) and remove the aroma preservation cover (15).
- Remove any beans with a vacuum cleaner.
- Remove the screw in the bean tank (Fig. 9) and fold the finger protection device up (Fig. 10).
- Insert the key (Fig. 11).
- Now turn the key counter-clockwise until the jammed stone is released.
- Remove any remaining powder with a vacuum cleaner.
- Fold the finger protection device (Fig. 10) down and screw it tight.
- Fill the bean tank with fresh beans.

14.7 Changing the filter

-  After 50 litres of water the filter cartridge will need to be replaced. The display will prompt you to change the filter.

Refer to Chapter 5.2 “Changing the filter”.

14.8 Prompt to run cleaning cycle

After having dispensed 220 products or after 80 rinsing cycles, the IMPRESSA must be cleaned. You will be informed of this by a message on the display. The machine will still make coffee, hot water and steam. However, we recommend that you should run the cleaning cycle (see Chapter 15) within the next few days.

- **DISPLAY** SELECT PRODUCT /
CLEAN MACHINE

After another 30 products the display will change. You should run the cleaning cycle now (see Chapter 15).

- **DISPLAY** SELECT PRODUCT /
CLEAN NOW

14.9 Prompt to decalcify

Lime scale builds up in the IMPRESSA as a result of normal use. The degree of calcification depends on the hardness of the water you use. The IMPRESSA recognizes when you should run a decalcifying cycle. The machine will still make coffee, hot water and steam. However, we recommend that you should decalcify the machine (see Chapter 16) within the next few days.

- **DISPLAY** SELECT PRODUCT /
DE-SCALE MACHINE



After a while the display will change. You should run the decalcifying cycle now (see Chapter 16).

- **DISPLAY** SELECT PRODUCT /
DE-SCALE NOW

14.10 Emptying the system

Requirements: The IMPRESSA has been switched off with the ON / OFF key , but the power switch (27) is still turned on.

-  This is necessary to protect the machine against damage occurring during transport as a result of frost.

- Place a receptacle under the pivoting spout (23).
- Press one of the Steam keys   until the following message is displayed:
- **DISPLAY** SYSTEM
EMPTYING

- When the process has been completed, the IMPRESSA switches itself off.

The display will read “FILL SYSTEM / PRESS STEAM” next time you switch the machine on. For more information, please refer to Chapter 3 “First use”.

14.11 General cleaning instructions

- Never use sharp objects or caustic chemicals for cleaning.
- Clean the case using a soft, damp cloth.
- Clean the pivoting nozzle after each use.
- After heating milk, draw off some hot water to clean the inside of the pivoting nozzle.
- Remove the Professional-Cappuccino Frother to clean it thoroughly.
- The water tank should be rinsed out and filled with fresh water daily.

 Visible calcification in the water tank can be removed using a commercial decalcifying agent. To do so, remove the water tank from the machine.

 If you are using a Claris filter cartridge, remove it from the tank first.

15. Cleaning

The IMPRESSA features an integrated cleaning program. The process takes approx. 15 minutes.

 Please contact your authorized dealer for JURA cleaning tablets that are suitable specifically for the cleaning program of your IMPRESSA. Please note that the use of unsuitable cleaning agents may cause damage to your machine and could leave unfavourable residues in the water.

 Once started, the cleaning process must not be interrupted.

 After each cleaning process, the filler funnel for the pre-ground coffee (17) should be cleaned as well.

- **DISPLAY** SELECT PRODUCT
CLEAN MACHINE

- Press Rinse  until the following message appears:

- **DISPLAY** EMPTY
TRAY / GROUNDS

- Empty out the drip tray (1) and integrated coffee grounds bin.

- **DISPLAY** TRAY
MISSING

- Place the empty, clean drip tray (1) and integrated coffee grounds bin back into the IMPRESSA.

- **DISPLAY** PRESS
RINSE

- Place a sufficiently large receptacle (ca. 0.5 litres) under the coffee spout (18).

- Press Rinse .

- **DISPLAY** MACHINE
CLEANING

- You will hear an acoustic signal.

- **DISPLAY** ADD
TABLET / PRESS RINSE

- Open the lid of the filler funnel for pre-ground coffee (17). Drop a JURA cleaning tablet inside (Fig. 12) and close the lid.

- Press Rinse .

- **DISPLAY** MACHINE
CLEANING

- You will hear an acoustic signal.

- **DISPLAY** EMPTY TRAY / GROUNDS
- Empty out the drip tray (1) and integrated coffee grounds bin.
- **DISPLAY** TRAY MISSING
- Place the empty, clean drip tray (1) and integrated coffee grounds bin back into the IMPRESSA.
- **DISPLAY** SELECT PRODUCT

 You can also trigger a cleaning cycle manually at any point in time (see Chapter 13.3).

16. Decalcifying

The IMPRESSA features an integrated decalcifying program. The process takes approx.50 minutes.

 Lime scale builds up in the IMPRESSA as a result of normal use. The degree of calcification depends on the hardness of the water you use. The IMPRESSA recognizes when you should run a decalcifying cycle. The machine will still make coffee and hot water/steam. However, we recommend that you should decalcify the machine within a few days after the message was displayed.

 Please contact your authorized dealer for JURA decalcifying tablets that are suitable specifically for the decalcifying program of your IMPRESSA. Please note that the use of unsuitable decalcifying agents may cause damage to your machine and could leave unfavourable residues in the water.

 Remove any splashes or drops of the decalcifying agent from sensitive surfaces, in particular surfaces made of natural stone or wood, or take appropriate preventive measures.

 Once started, the decalcifying program must not be interrupted.

 Always wait until the decalcifying agent has been used up and the tank is empty. Never fill in additional decalcifying agent.

■ **DISPLAY** SELECT PRODUCT DE-SCALE MACHINE

■ Press Rinse , until the following message appears:

■ **DISPLAY** EMPTY TRAY / GROUNDS

■ Empty out the drip tray (1) and integrated coffee grounds bin.

■ **DISPLAY** TRAY MISSING



■ Place the empty, clean drip tray (1) and integrated coffee grounds bin back into the IMPRESSA.

■ **DISPLAY** AGENT IN TANK / PRESS STEAM

■ Take out the water tank (14). Empty out any remaining water.

Completely dissolve the content of one blister (3 tablets) in a receptacle containing 0.6 litres of water, and pour the mixture into the water tank. Place the water tank back into the machine.

■ Remove the 2-stage frothing jet (24) or Professional-Cappuccino Frother from the machine (if attached).



■ Place a tall receptacle under the pivoting spout (23) and press one of the Steam keys  .

■ **DISPLAY** MACHINE DE-SCALING

■ You will hear an acoustic signal.



■ **DISPLAY** OPEN TAP



■ Place the receptacle under the hot water spout (25).

- Turn the Hot Water key (22) to the  symbol.
- **DISPLAY** MACHINE
DE-SCALING
- You will hear an acoustic signal.
- **DISPLAY** CLOSE TAP
- Turn the Hot Water key (22) to the  symbol.
- **DISPLAY** MACHINE
DE-SCALING
- You will hear an acoustic signal.
- **DISPLAY** EMPTY
TRAY / GROUNDS
- Empty out the drip tray (1) and integrated coffee grounds bin.
- **DISPLAY** TRAY
MISSING
- Place the empty, clean drip tray (1) and integrated coffee grounds bin back into the IMPRESSA.
- **DISPLAY** FILL / RINSE
WATER TANK



Thoroughly rinse out the water tank and fill it with fresh cold tap water. Then place it back into the IMPRESSA.

- **DISPLAY** PRESS STEAM
- Place a receptacle under the pivoting spout (23).
- Press one of the Steam keys  .
- **DISPLAY** MACHINE
DE-SCALING
- You will hear an acoustic signal.
- **DISPLAY** OPEN TAP
- Place the receptacle under the hot water spout (25).
- Turn the Hot Water key (22) to the  symbol.

- **DISPLAY** MACHINE
DE-SCALING
- You will hear an acoustic signal.
- **DISPLAY** CLOSE TAP
- Turn the Hot Water key (22) to the  symbol.
- **DISPLAY** MACHINE
DE-SCALING
- You will hear an acoustic signal.
- **DISPLAY** EMPTY
TRAY / GROUNDS
- Empty out the drip tray (1) and integrated coffee grounds bin.
- **DISPLAY** TRAY
MISSING
- Place the empty, clean drip tray (1) and integrated coffee grounds bin back into the IMPRESSA.
- **DISPLAY** PRESS RINSE
- Place a receptacle under the height-adjustable coffee spout (18) and press Rinse .
- **DISPLAY** MACHINE RINSING
- **DISPLAY** SELECT PRODUCT



You can also trigger a decalcifying cycle manually at any point in time (see Chapter 13.3).

17. Disposal

Please return the IMPRESSA to your local dealer, the service shop or to JURA for proper disposal.

18. Tips for perfect coffee

Height-adjustable coffee spout (18)

You can adjust the height of the coffee spout to the size of your cups.

Grinding degree

Refer to Chapter 2.5 “Adjusting the grinding gear”.

Preheating cups

The machine features a heatable cup shelf (19). You can, however, additionally preheat the cups with hot water. The smaller the quantity of coffee you make, the more important preheating is.

Sugar and cream

Stirring causes heat to be released. Adding refrigerated cream or milk will reduce the temperature of the coffee significantly.

19. Problems

Problem	Cause	Remedy
Grinding gear makes a very loud noise	Foreign body in the grinding gear	Please refer to Chapter 14.6
Too little froth when frothing milk	Profi-Auto-Cappuccino nozzle clogged	Clean nozzle (Chapter 11.5)
Coffee only drips from the coffee spout	Grinding degree too fine	Adjust grinding gear to coarser grind
	Pre-ground coffee too fine	Use a coarser type of pre-ground coffee
Display constantly indicates 'Tray missing'	Soiled metal contacts at rear of drip tray (Fig. 13)	Clean metal contacts
'Fill beans' not displayed despite empty bean tank	Bean monitoring system soiled	Clean bean tank (dry)

20. Legal information

These operating instructions contain all the information required for operating and maintaining the machine properly.

Knowledge of and compliance with the specifications contained in these operating instructions is required for using the machine safely as well as for operational safety and safety during maintenance.

These operating instructions cannot cover all conceivable applications. The machine was designed for private household use.

Additionally, we point out that the contents of these operating instructions do not modify or form part of any previous or existing agreement, consent or legal relationship. Any obligations to be fulfilled by JURA Elektroapparate AG are stipulated in the corresponding purchase contract which also contains the full and solely applicable warranty terms. These contractual warranty terms are neither extended nor limited by the specifications contained in these operating instructions.

The operating instructions contain information that is protected by Copyright. Photocopying or translations into other languages shall not be permissible without JURA Elektroapparate AG's written approval.

21. Technical data

Voltage:	230 V AC
Power:	1350 W
Fuse:	10 A
Safety check:	
Economy Mode – power consumption:	40 Wh
Economy Mode 1 power consumption:	20 Wh
Economy Mode 2 power consumption:	15 Wh
Pump pressure:	static max. 15 bar
Water tank:	2.7 litres
Bean tank capacity:	280 g.
Coffee grounds bin capacity:	max. 16 portions
Length of cable:	approx. 1.1 m
Weight:	11.9 kg
Dimensions (WxHxD):	34.5 x 35 x 39 cm

This appliance complies with the following EC directives:
73/23/EEC of February 19th, 1973, “Low Voltage Directive” and amending directive 93/336/EEC.

89/336/EEC of May 3rd, 1989, “EMC Directive” and amending directive 92/31/EEC.